



ICON™



Confidence by Design.

An elevated hygiene experience engineered to give you control.

CONFIDENCE BY DESIGN

ICON™ Collection

Only the Kimberly-Clark Professional™ ICON™ system lets you take control without compromise by offering game changing hygiene combined with a new standard in performance and experience in order to deliver complete confidence in the washroom.

Engineered to provide you confidence, designed to elevate your space.

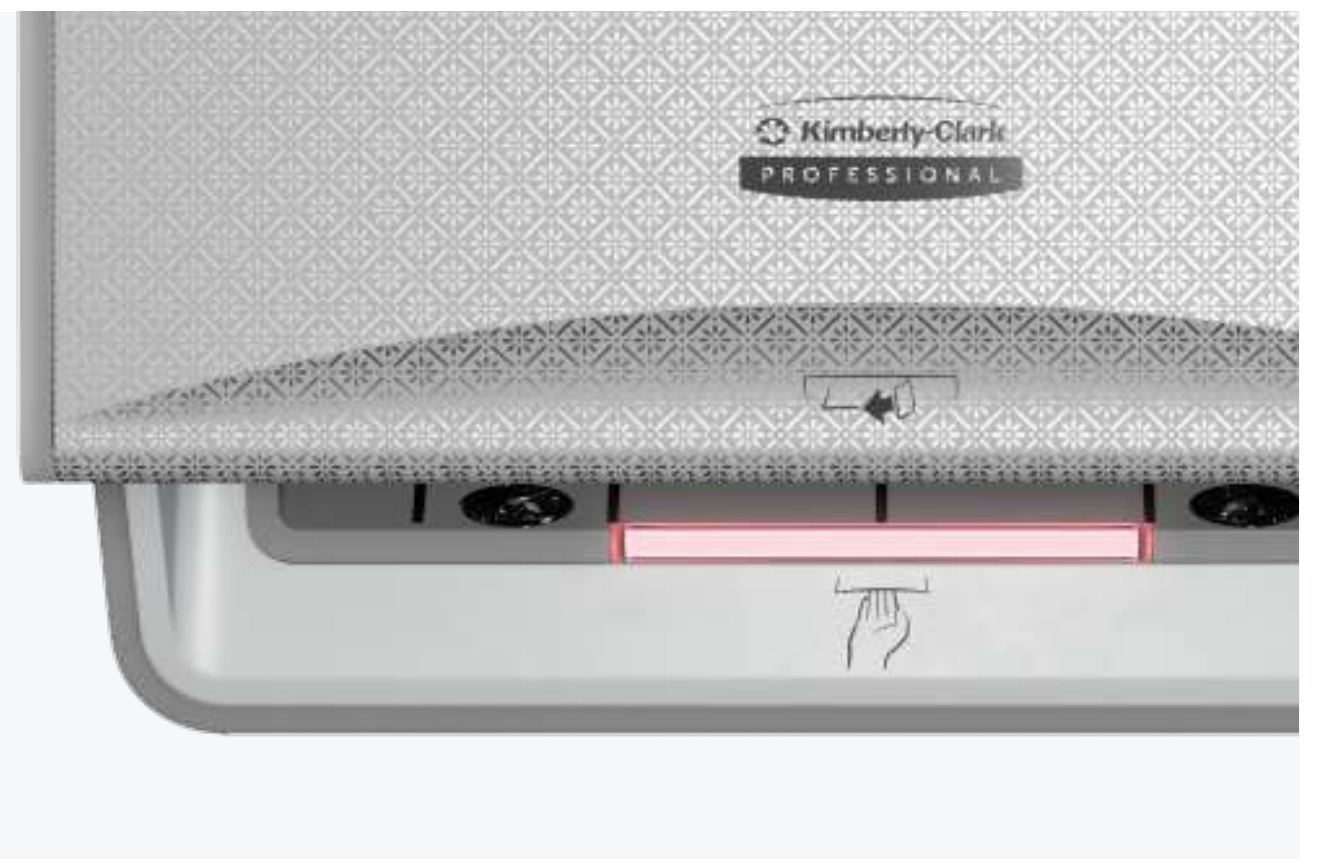



ICON™ COLLECTION

Interchangeable faceplates

Engineered for a quick and seamless washroom transformation, our interchangeable faceplates can be easily removed and securely replaced.

ICONIC STYLE

Natural Accents

Choose from a unique selection of faceplates designed to add a natural accent to your washroom environment. Current designs include a warm marble, cherry blossom and a deep, authentic, ebony woodgrain.

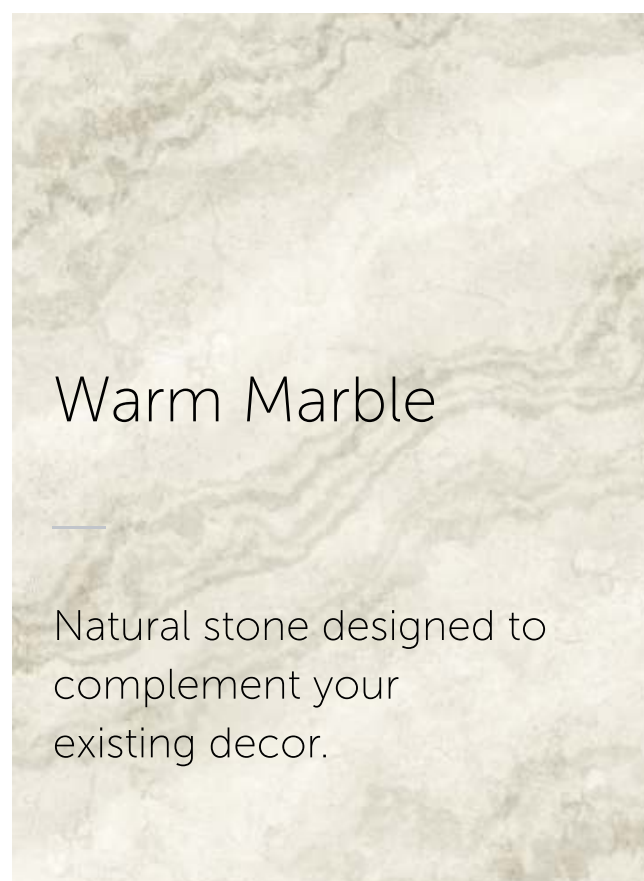

Warm Marble

Natural stone designed to complement your existing decor.



Cherry Blossom

A soothing, natural aesthetic to bring calm to any environment.



Ebony Woodgrain

Deep authentic wood texture provides a dark but natural ambiance.

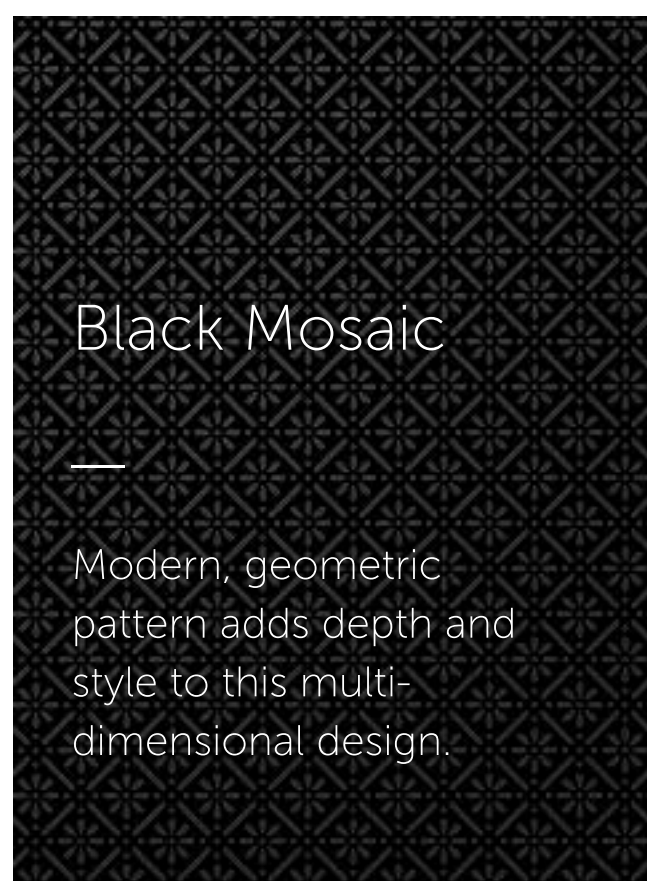

Black Mosaic

Modern, geometric pattern adds depth and style to this multi-dimensional design.

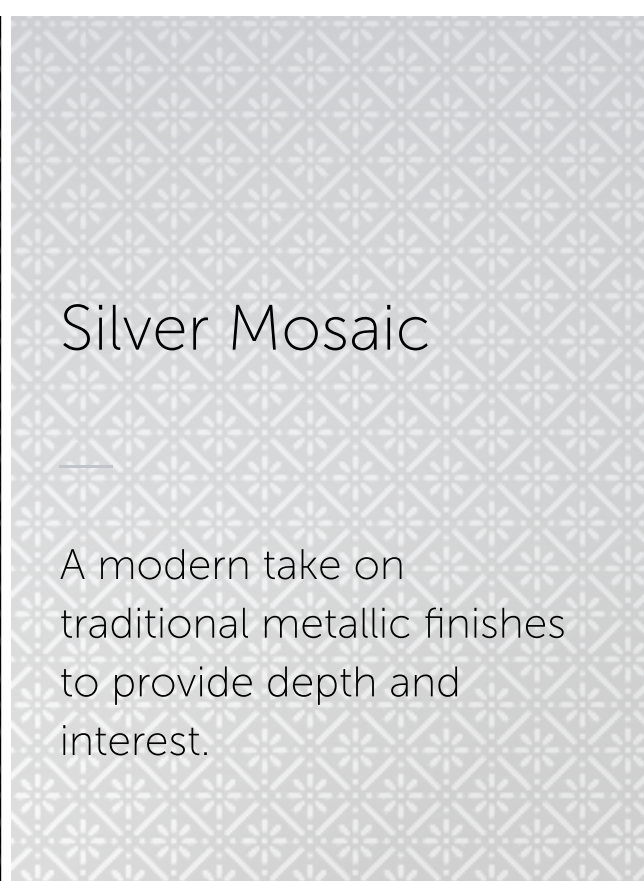

Silver Mosaic

A modern take on traditional metallic finishes to provide depth and interest.



White Mosaic

Subtle texture that becomes more engaging the closer you get.

ICONIC STYLE

Contemporary Classics

Our range of contemporary classic faceplates offers a practical, yet modern take on traditional black, white, and silver finishes. Subtle, geometric patterning adds depth and style to the conventional flat colour finish.

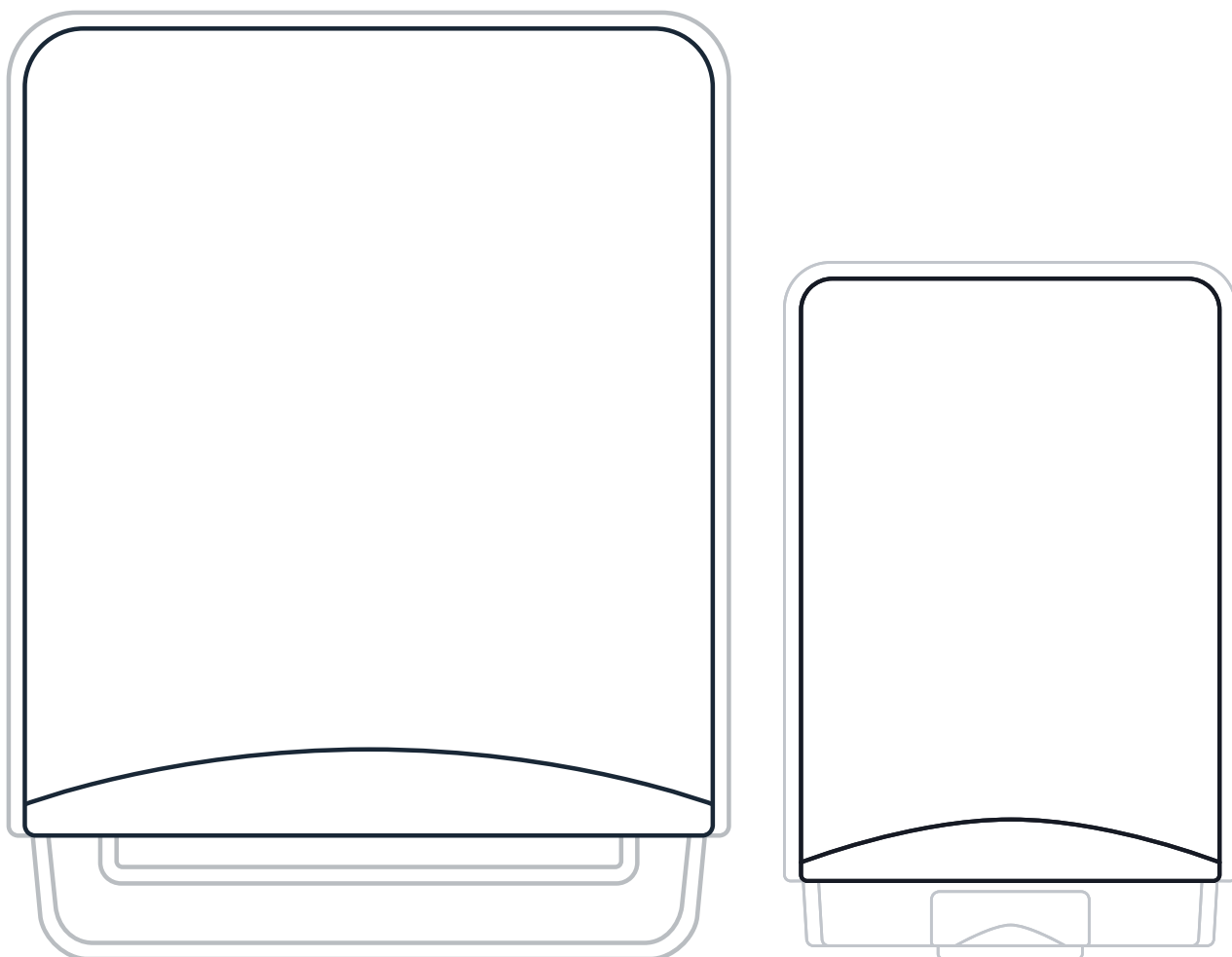
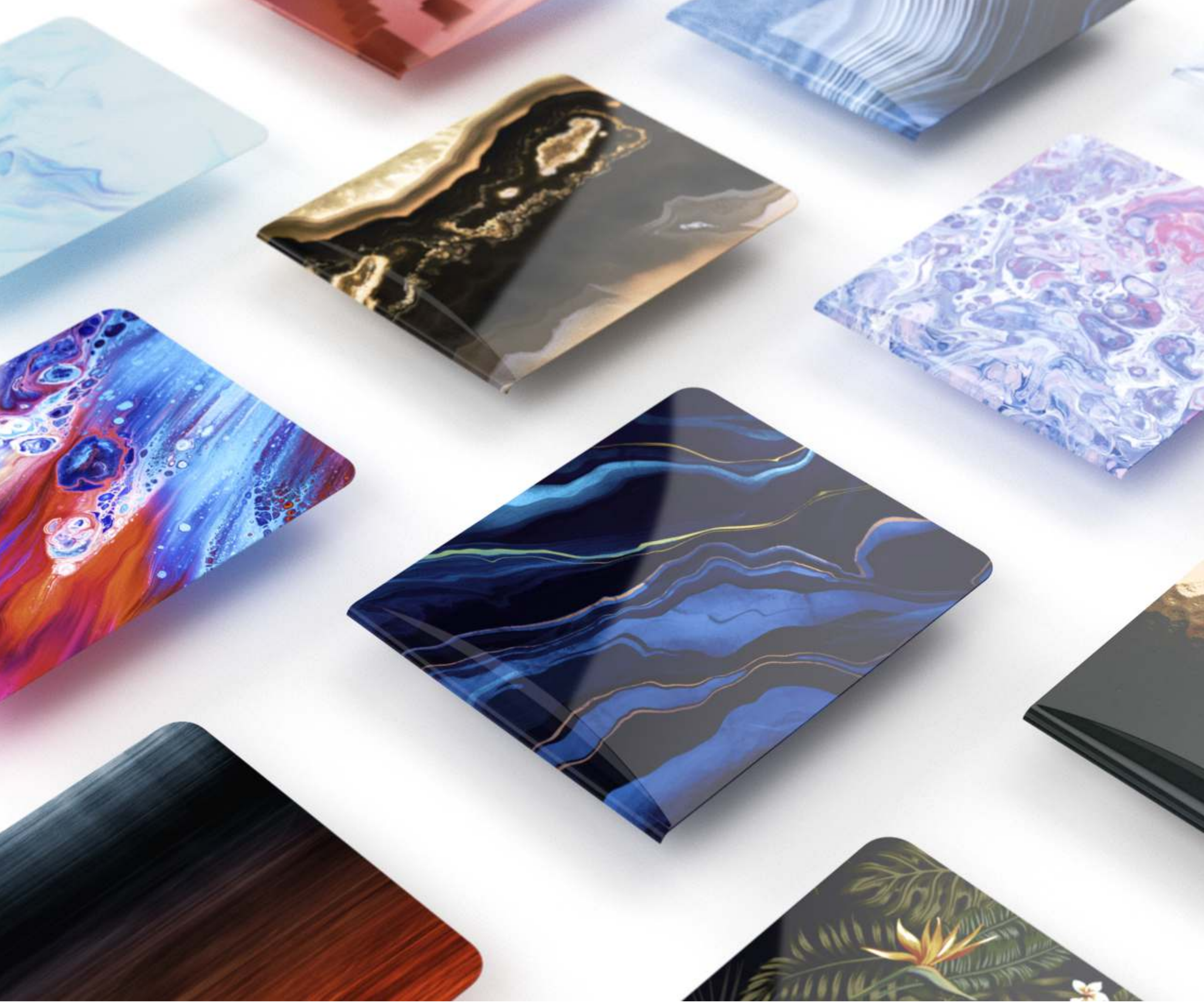

CUSTOM FACEPLATES

Endless possibilities

Bring adaptable style and sophistication into your space. Envision an environment for creative expression, as well as unique engagement opportunities, and untap branding and advertising potential with an innovative messaging platform.

Responsible partners in sustainability.



Kimberly-Clark Professional™ supports businesses in improving recycling rates and reducing their waste footprint – ensuring a better future for people, for businesses, and the planet.



REDUCING PLASTICS

Bio-Based Core Plugs

The ICON™ dispenser is complemented with a full set of visibly branded consumables across all three experience tiers (Standard, Plus & Premium) featuring our plastic-free core plugs as standard on our rolled hand towels. Our plastic-free core plugs will help you meet your environmental objectives in reducing plastics with no effect on dispensing performance.

-  Patented bio-based core plugs made primarily from starch and cellulose fibres
-  100% recyclable in paper recycling streams
-  Cleaners save time with less waste segregation

MORE SUSTAINABLE

Reduce Waste and Consumption

The ICON™ hand towel dispenser allows you to cut your consumption by up to a third versus the leading competitor folded hand towel and the stub roll feature allows for up to 100% product utilisation.¹

Kleenex® rolled hand towels designed for the ICON™ dispenser use up to 33% less paper fibre per hand dry than leading competitor's standard folded hand towels.¹

ICON™ | Kimberly-Clark
PROFESSIONAL™
Confidence by Design.



Hassle-free recycling for dispensers and Kimberly-Clark Professional™ hand towels.

DISPENSER RECYCLING

The world's first dispenser installation and recycling service

Our professional fitters will remove, collect and recycle your old dispensers – no matter who the manufacturer is – and ensure your workplace remains healthy, safe and productive during installation.



We'll ensure new dispensers are loaded, ready for use, and cleaning staff are completely confident in how to operate and service them.

-  New dispensers are covered by our Lifetime Guarantee[†]
-  Peace of mind - from start to finish

HAND TOWEL RECYCLING

Transform used hand towels into new Kimberly-Clark Professional™ products

With no up front investment or additional labour, RightCycle™'s "closed loop" service recycles your paper towels as easily as throwing them away, with all the additional benefits to your business – and the planet.

-  Meet your sustainability goals
-  Divert waste from landfill
-  Demonstrate your commitment to sustainability

¹Results of Hall Test conducted by Sapio agency July 2021.

ICON™



Electronic Rolled Hand Towel Dispenser

An elevated hygiene
experience engineered
to give you control.





CONFIDENCE BY DESIGN

Electronic Rolled Hand Towel Dispenser

Elevate your space with the latest advancement in reliable and hygienic dispensing.

Thoughtfully engineered with a focus on sustainability and design, the Kimberly-Clark Professional™ ICON™ rolled hand towel system refines every interaction of the dispensing experience from servicer to end-user.

The Kimberly-Clark Professional™ ICON™ rolled hand towel dispenser, reduces refill times by delivering up to three times the number of hand dries per fully loaded dispenser than leading folded hand towel competitors.¹



¹Hall Test conducted by Sapio Research Agency in July 2021

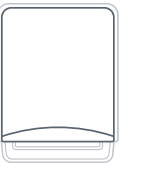

ICON™ COLLECTION

Game Changing Hygiene

The Kimberly-Clark Professional™ ICON™ dispenser was designed with a goal to reduce the potential of cross contamination. Taking into account every interaction, the ICON™ dispenser is a next-level hygiene experience engineered to minimise the risk of spreading germs from every touchpoint.

The Kimberly-Clark Professional™ ICON™ hand towel dispenser rated the most preferred for workplace washrooms.¹

¹Hall Test conducted by Sapio Research Agency in July 2021



Touchless Dispensing

Reduce the risk of spreading germs with contactless dispensing.



Minimised Maintenance Touch-points

Intuitive servicing with less time in contact with the towel roll reduces the opportunity for cross contamination.



Hidden Towel Mode

Minimise chances for airborne contaminants and keep paper inside dispenser until user prompted.



ADVANCED TECHNOLOGY

Ultimate Dispensing Experience

Designed to provide a more controlled and sustainable washroom experience that makes it effortless for clients, servicers and choosers alike. Our ICON™ hand towel dispenser builds on Kimberly-Clark Professional's 150-year history in innovation, delivering our most technologically advanced system to date.

4 out of 5 people rated the Kimberly-Clark Professional™ ICON™ rolled hand towel dispenser system better than the leading competition for hand drying satisfaction.¹

¹Results of Hall Test research conducted by Sapio Research Agency July 2021



Streamlined Dispensing

Towels are ready when you are because of a patented dual sensor design that precisely dispenses the amount of paper towels required.



Nearly Noiseless Operation

With practically noiseless operation, the ICON™ hand towel system is the quietest dispenser available today.



Efficient Servicing

LED lights communicate when a unit needs attention, minimising time wasted and reducing touchpoints for a more hygienic experience.

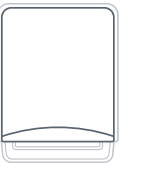

PERFORMANCE

Performance and Efficiency

The latest in advanced engineering, ICON™ from Kimberly-Clark Professional™, is designed to set a new standard of dispensing. ICON™ enables you to control your waste and meet your key performance indicators, providing reliability and a level of system efficiency you can depend on.



Comprehensive Lifetime Warranty for our ICON™ dispenser collection†

Proudly offered by Kimberly-Clark Professional™



Jam-free Operation

The Kimberly-Clark Professional™ ICON™ dispenser uses a patented dual sensor design delivering 99.9% jam free performance.¹



100% Product Use

Minimise waste and maximise use with stub roll capability that enables restocking before the roll is empty, streamlining maintenance.



Long-lasting Battery Life

Get more than 150,000 dispenses on a single set of batteries in the energy efficient ICON™ hand towel dispenser.²

¹Dispensing test conducted by Patmore Slade Horizons in September 2021

²Based on an average of 30,000 dispenses per year using historical usage and foot traffic data

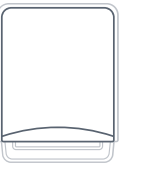

SERVICING

Designed to be effortless

Engineered with you in mind, every detail of the ICON™ dispenser has been refined to offer an unsurpassed experience. Other dispensers are designed around paper.

The ICON™ dispenser is designed around you.



The Kimberly-Clark Professional™ ICON™ dispenser:
Our best servicing experience yet¹



Flexible Accessibility Options

Versatile locking mechanism options include push button entry and a custom key entry location for increased accessibility.



Controlled Opening

ICON™'s sophisticated dampened hinge technology controls opening to make changeouts effortless.



Colour-coded Touchpoints

Maintenance is simplified through a colour-coded system with intuitive touch points that minimises contact, for a more hygienic paper towel change-over.

¹Based on Kimberly-Clark Professional™ janitor study

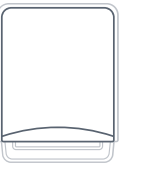

REFINED MAINTENANCE

Touch panel simplicity

The easy-to-read touch panel is designed for intuitive servicing while preventing accidental setting adjustments.

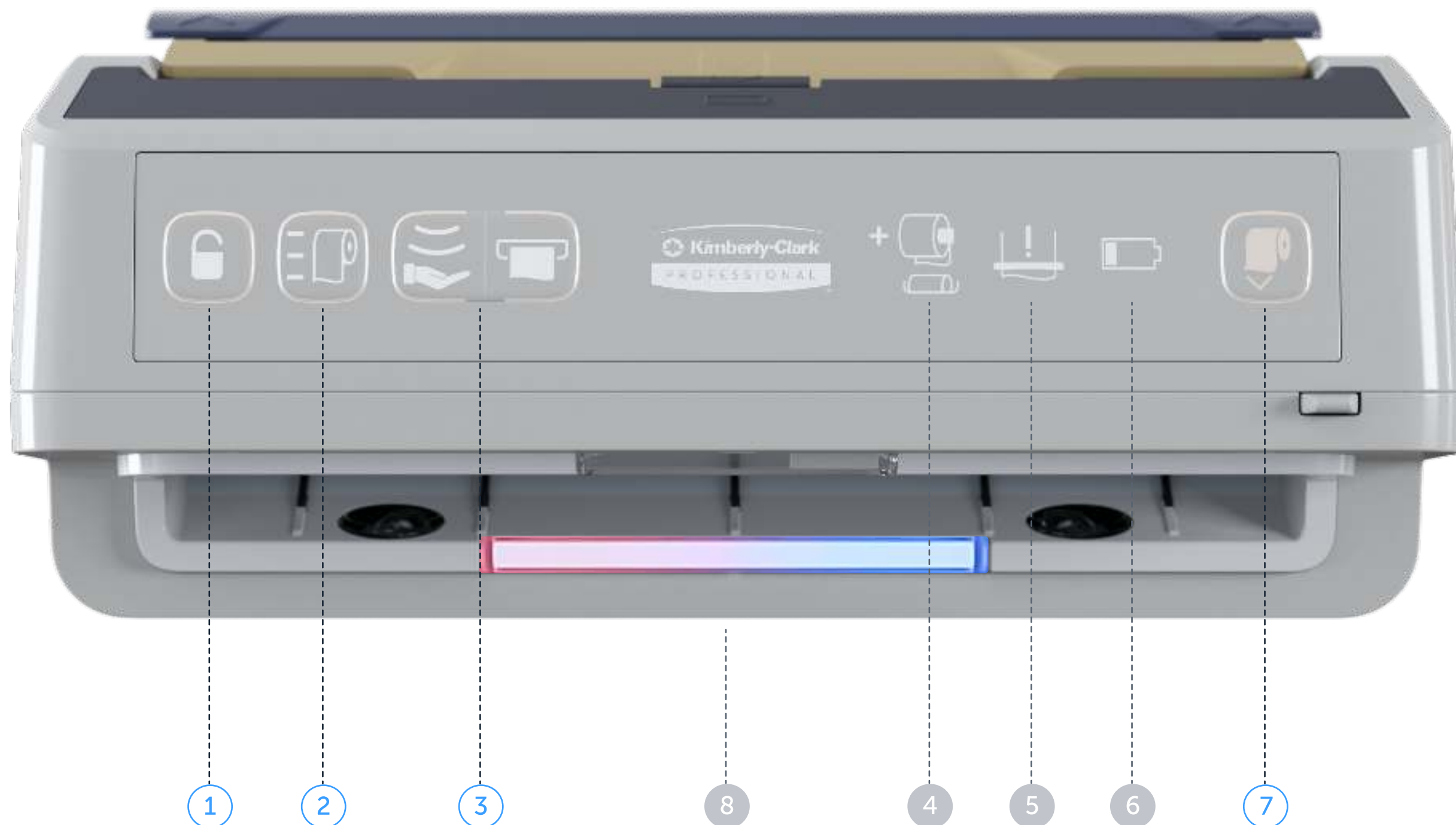

CONTROLS

- 1 Lock-out feature**
Prevents accidental setting changes. Hold button for 3 seconds to unlock.
- 2 Towel length**
Select from 3 sheet length options: 10" (25.40cm), 12" (30.48cm) and 14" (35.56cm).
- 3 Sensor sensitivity/Hanging mode**
Set towel in hidden or hanging mode and adjust sensor to 2 levels of sensitivity.
- 7 Feed paper**
Manually feed paper with a touch of a button for refined reloading.

INDICATOR LIGHTS

- 4** Indicates new roll/stub roll change
- 5** Paper jam indicator
- 6** Low battery indicator

SERVICER ALERT LED

- 8** Blue - low paper alert
Red - maintenance alert



OVERVIEW

ICON™ Electronic
Rolled Hand Towel Dispenser –
Wall Mount

Dimensions (W x H x D)	Qty/Case
31.5cm x 42cm x 25.88cm 12.41" x 16.53" x 10.19"	1x

Lifetime Warranty† ✓

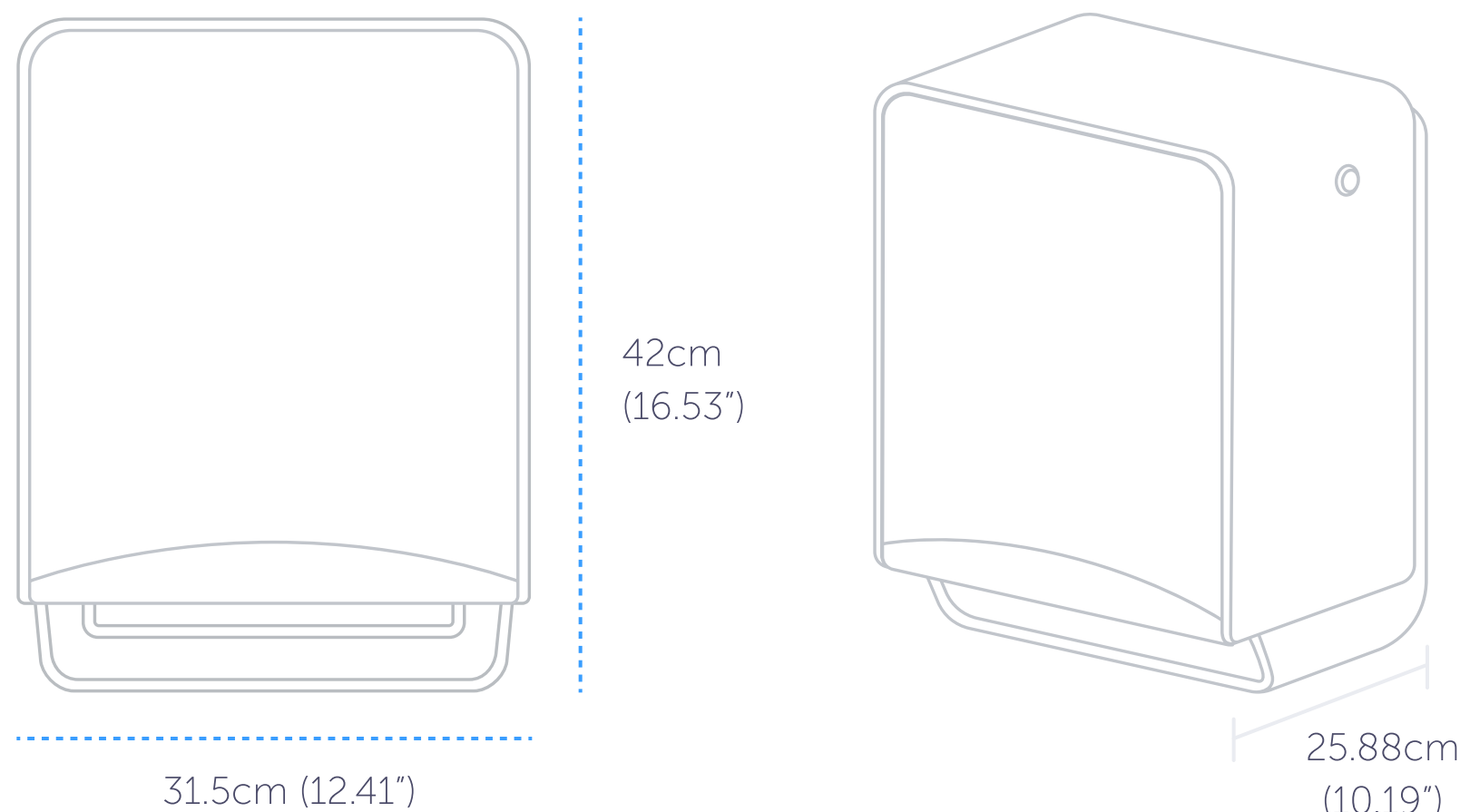

TECHNICAL SPECIFICATIONS

Suggested mounting height is 122cm (48") from the floor or 30.5cm (12") above a counter.

Required clearance

42cm (16.53") x 31.5cm (12.41") flat wall space.



DISPENSER UNITS

- Grey housing with Silver Mosaic faceplate (53691)
- White housing with White Mosaic faceplate (53940)

INTERCHANGEABLE FACEPLATES

- Black Mosaic (58780)
- Silver Mosaic (58760)
- White Mosaic (58770)
- Ebony Woodgrain (58830)
- Cherry Blossom (58820)
- Warm Marble (58790)

PRODUCT FEATURES

- Patented dual sensors, precisely dispense the amount of paper towels desired
- Long-lasting battery life, single set of batteries can last for more than 150,000 dispenses³
- Practically noiseless dispensing - the quietest on the market today¹
- Flexible accessibility options. Versatile locking mechanism options include push button entry and a custom key entry
- LED Indicator lights, communicate when a unit needs attention, minimising touchpoints
- Dampened hinge technology, controlled opening makes changeouts an easy-to-complete, one-handed operation
- Jam-free operation, proven 99.9% jam-free dispensing performance²
- Colour coded touch-points, minimises contact for a more hygienic paper towel change-over
- 100% product use, stub roll capability that enables restocking before the roll is empty
- Three sheet length and two sensor sensitivity settings

¹Against leading competition | ²Dispensing test conducted by Patmore Slades Horizons in September 2021
³Based on an average of 30,000 dispenses per year using historical usage and foot traffic data









ICON™ COLLECTION

Rolled Hand Towel

To learn more about product bundles please contact your Kimberly-Clark Professional Sales Representative or visit www.kcprofessional.co.uk.



- ✓ Ecolabel certified for reduced environmental impact
- ✓ FSC® certified

STANDARD ✓✓✓	PLUS ✓✓✓	PREMIUM ✓✓✓
<p>Scott</p> <p>Scott® Essential™ Rolled Hand Towel 6638</p> <p>380m per roll</p> <p>✓✓</p> 	<p>Kleenex</p> <p>Kleenex® Rolled Hand Towel 6646</p> <p>250m per roll</p> <p>✓✓</p> 	<p>Kleenex</p> <p>Kleenex® Ultra™ 2-ply Rolled Hand Towel 6782</p> <p>200m per roll</p> <p>✓✓</p> 
<p>Scott</p> <p>Scott® Essential™ Slimroll™ Hand Towel 6639</p> <p>180m per roll</p> <p>✓✓</p> 	<p>Kleenex</p> <p>Kleenex® Slimroll™ Hand Towel 6648</p> <p>135m per roll</p> <p>✓✓</p> 	<p>Kleenex</p> <p>Kleenex® Ultra™ Slimroll™ 2-ply Rolled Hand Towel 6783</p> <p>110m per roll</p> <p>✓✓</p> 

ICON™



Electronic Skincare Dispenser

An elevated hygiene
experience engineered to
give you control.

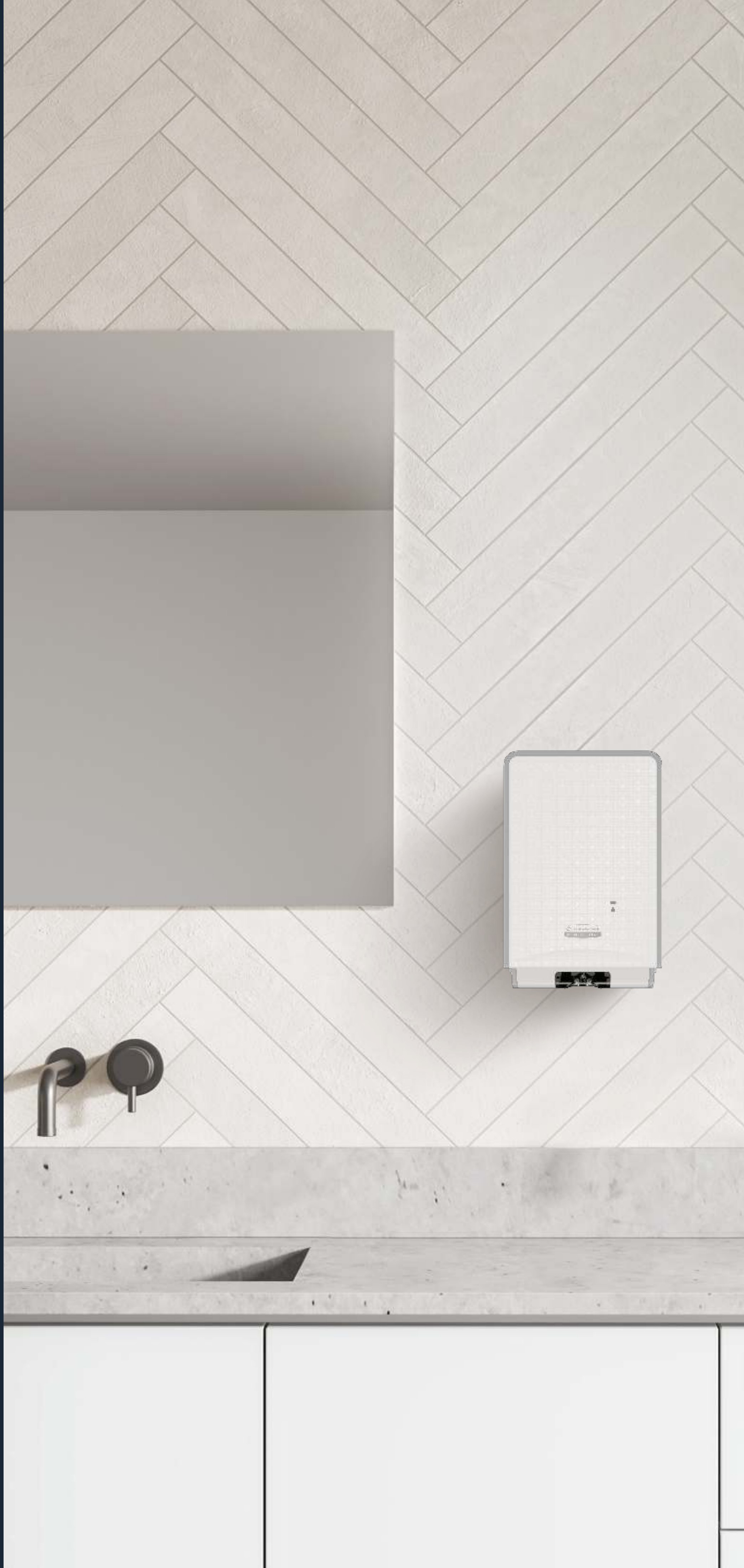



CONFIDENCE BY DESIGN

Skincare

Elevate your space with the latest advancement in reliable skincare dispensing.

Thoughtfully engineered with an eye on aesthetics and sustainability, the Kimberly-Clark Professional™ ICON™ skincare system refines every interaction of the dispensing experience from server to end-user.

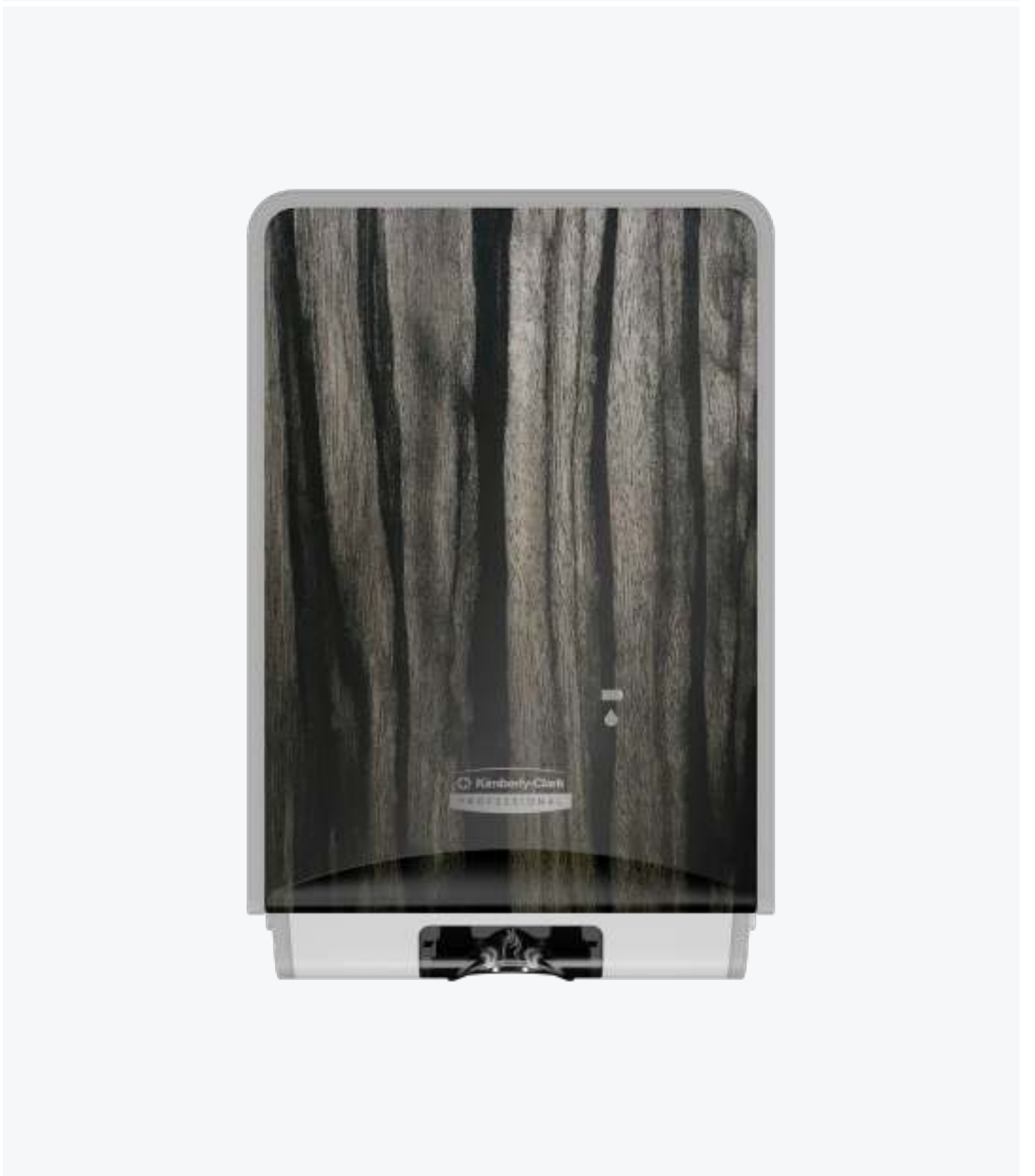



REFINED TECHNOLOGY

Hand hygiene by design

Redefine the washroom with an elevated experience in hand hygiene.

With touchless operation, seamless servicing and first-in-its-class performance, the Kimberly-Clark Professional™ ICON™ skincare dispenser is changing the game in hand hygiene and going beyond the ordinary.



Comprehensive Lifetime Warranty for our ICON™ dispenser collection.†

Proudly offered by Kimberly-Clark Professional™



Contactless dispensing

Touchless operation reduces cross-contamination and the spread of germs.



Fast loading for easy servicing

Designed with increased accessibility and a smooth opening and closing experience.



Next level hand hygiene

The ICON™ dispenser's elevated design brings together efficiency and performance with up to 60,000 dispenses per dispenser battery set.¹

¹Based on testing using GP batteries. Performance may vary depending on batteries available in your country



OVERVIEW

ICON™ Electronic Skincare Dispenser

Elevated design brings together efficiency and performance with up to 60,000 dispenses per dispenser battery set.¹

Dimensions (W x H x D)	Qty/Case
19cm x 29.7cm x 10.1cm 7.50" x 11.70" x 3.98"	1x

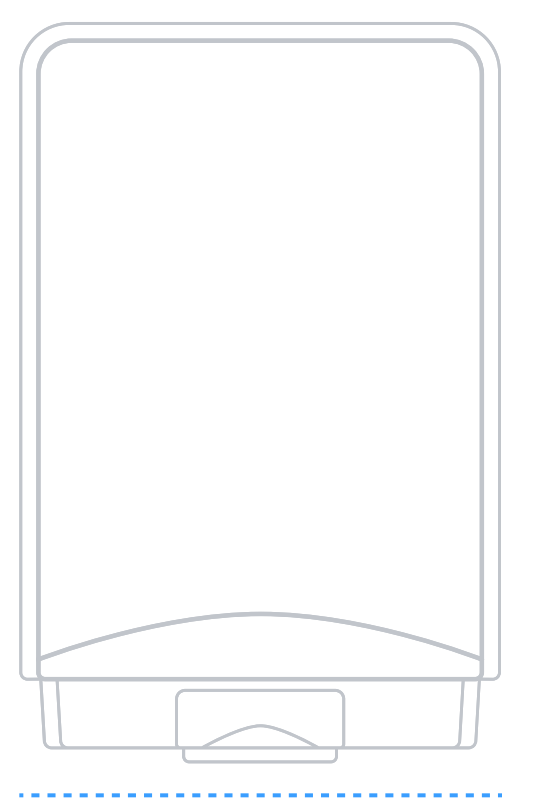

19cm (7.50")

29.7cm
(11.70")

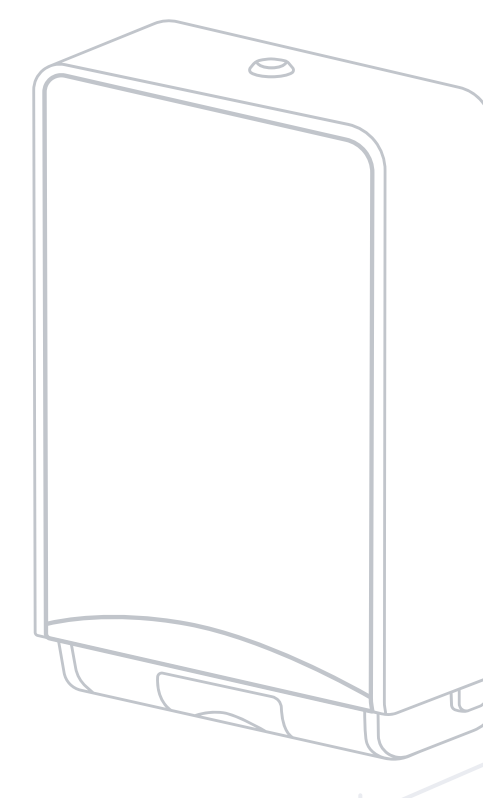

10.1cm
(3.98")

TECHNICAL SPECIFICATIONS

Suggested mounting height is 122cm (48") from the floor or 40cm (15.56") above a counter.

Lifetime Warranty† ✓

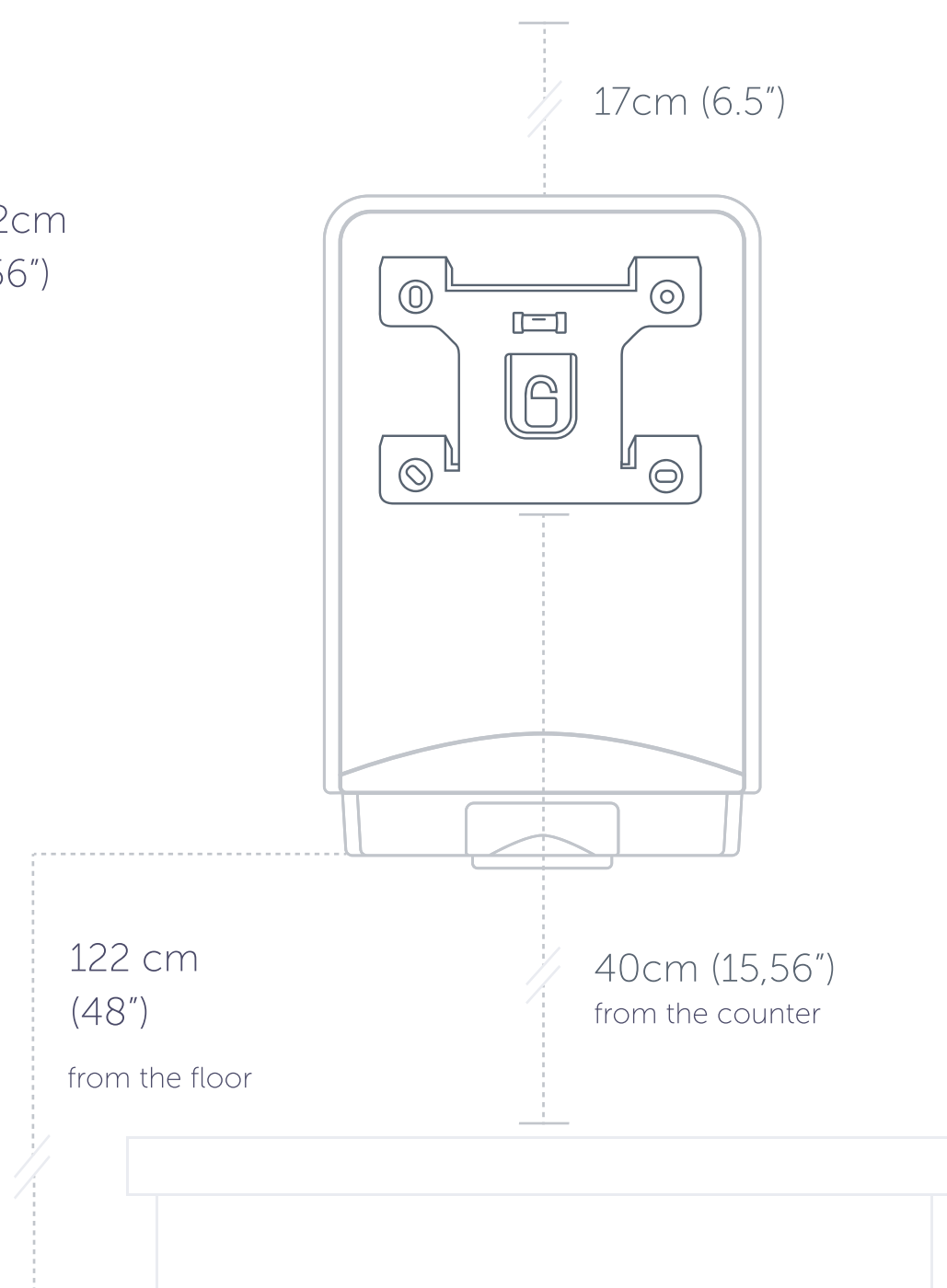

17cm (6.5")

122 cm
(48")
from the floor

40cm (15.56")
from the counter

DISPENSER UNITS

- Grey housing with Silver Mosaic faceplate (53694)
- White housing with White Mosaic faceplate (53944)

INTERCHANGEABLE FACEPLATES

- Black Mosaic (58784)
- Silver Mosaic (58764)
- White Mosaic (58774)
- Ebony Woodgrain (58834)
- Cherry Blossom (58824)
- Warm Marble (58794)

PRODUCT FEATURES

- Fast loading for easy servicing with increased accessibility and a smooth opening experience
- Simplified installation process with custom engineered mounting brackets, a built-in level and clip-on mounting
- First-in-its-class performance with up to 60,000 dispenses per dispenser battery set¹
- Touchless operation helps reduce the risk of cross contamination and the spread of germs
- Flexible accessibility options by push button entry or lockable by key

¹Based on testing using GP batteries. Performance may vary depending on batteries available in your country









ICON™ COLLECTION

Skincare

To learn more about product bundles please contact your Kimberly-Clark Professional Sales Representative or visit www.kcprofessional.co.uk.



✔ Ecolabel certified for reduced environmental impact

ICON™ COLLECTION	STANDARD ✔ ✔ ✔	PREMIUM ✔ ✔ ✔
<p></p> <p>HAND CLEANSER</p>	<p></p> <p><i>Scott</i></p> <p>Scott® Control™ Hand Cleanser 6345 ✔</p> <p>Unperfumed</p>	<p></p> <p><i>Kleenex</i></p> <p>Kleenex® Botanics™ Fresh Hand Cleanser 6396</p> <p>Refreshing fragrance</p>
<p></p> <p>HAND SANITISER</p>	<p></p> <p><i>Scott</i></p> <p>Scott® Control™ Foam Hand Sanitiser 6393</p> <p>Unperfumed</p>	<p></p> <p><i>Kleenex</i></p> <p>Kleenex® Gel Hand Sanitiser 6383</p> <p>Unperfumed</p>

ICON™

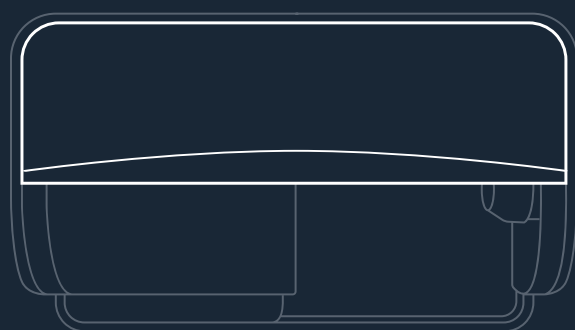
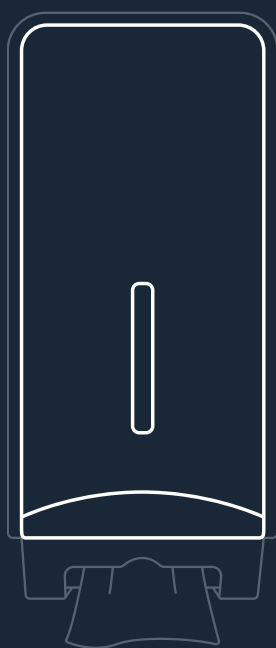

Toilet Paper Dispensers

An elevated hygiene
experience engineered to
give you control.





CONFIDENCE BY DESIGN

Toilet Paper Dispensers

The Kimberly-Clark Professional™ ICON™ toilet paper dispensers compliment the ICON™ Collection hand hygiene range, including interchangeable faceplates for a consistent washroom appearance. Available in standard roll and folded bath tissue formats.

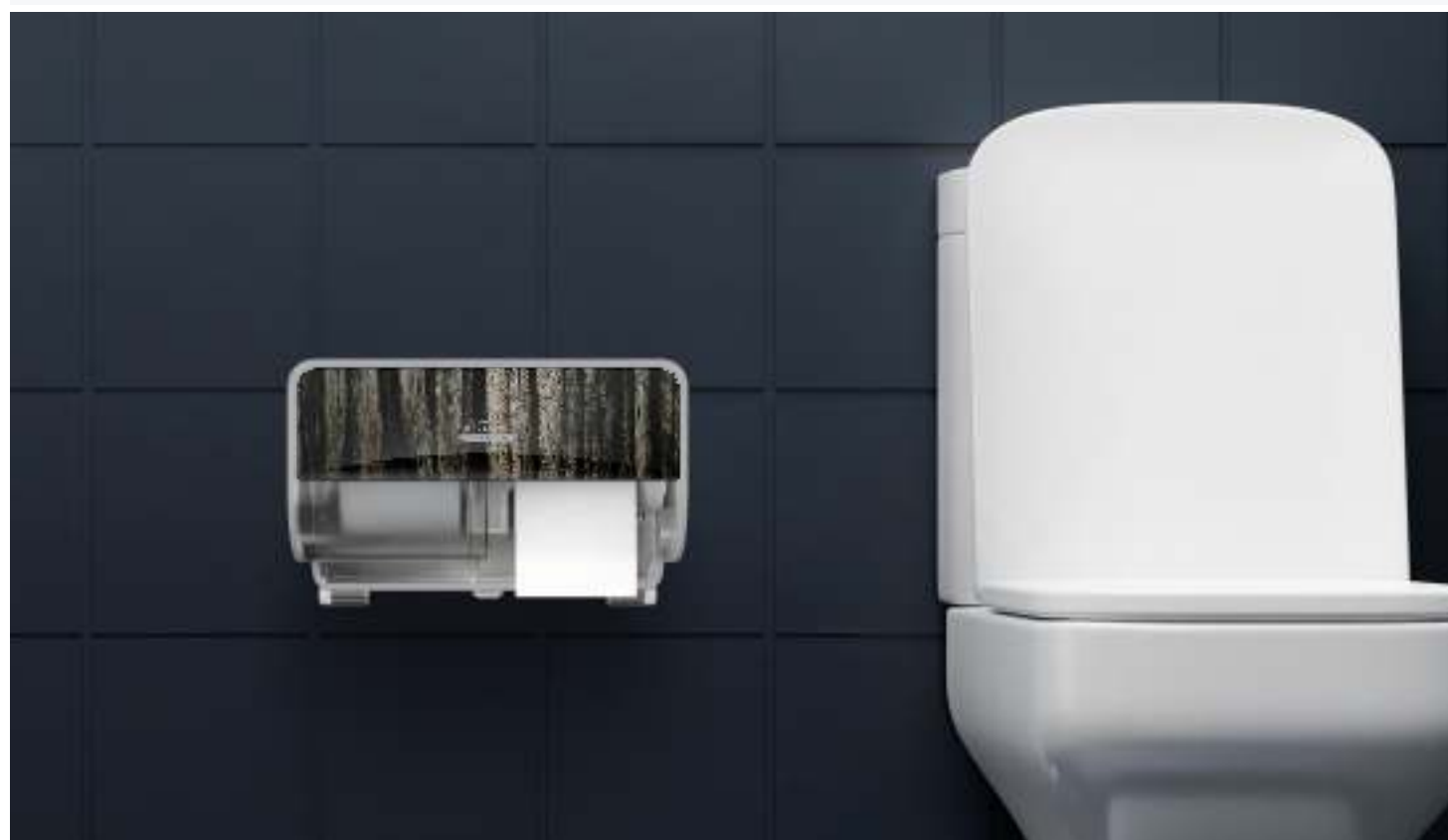



REFINED TECHNOLOGY

Redefine the washroom

The ICON™ dispensers are designed for efficiency with more infrequent and faster servicing. The design takes the washroom to the next level of hygiene without compromising style.

Comprehensive Lifetime Warranty for our ICON™ dispenser collection.†

Proudly offered by Kimberly-Clark Professional™



Complementary Design

Sleek and stylish yet suited for high-traffic washrooms, with different toilet paper options to meet your needs.



Simplified Servicing

Engineered with increased accessibility for easy refilling.



Engineered for Less Waste

Designed to get more out of your toilet paper supply to minimise waste with fewer changeouts.



OVERVIEW

ICON™ Horizontal Toilet Paper Dispenser for Standard Roll

The ICON™ standard roll horizontal toilet paper dispenser is designed for efficiency with less frequent and faster servicing. The design takes the washroom to the next level of hygiene with uncompromising style.

Dimensions (W x H x D)	Qty/Case
32.39cm x 21.27cm x 18.42cm	1x
12.75" x 8.37" x 7.25"	

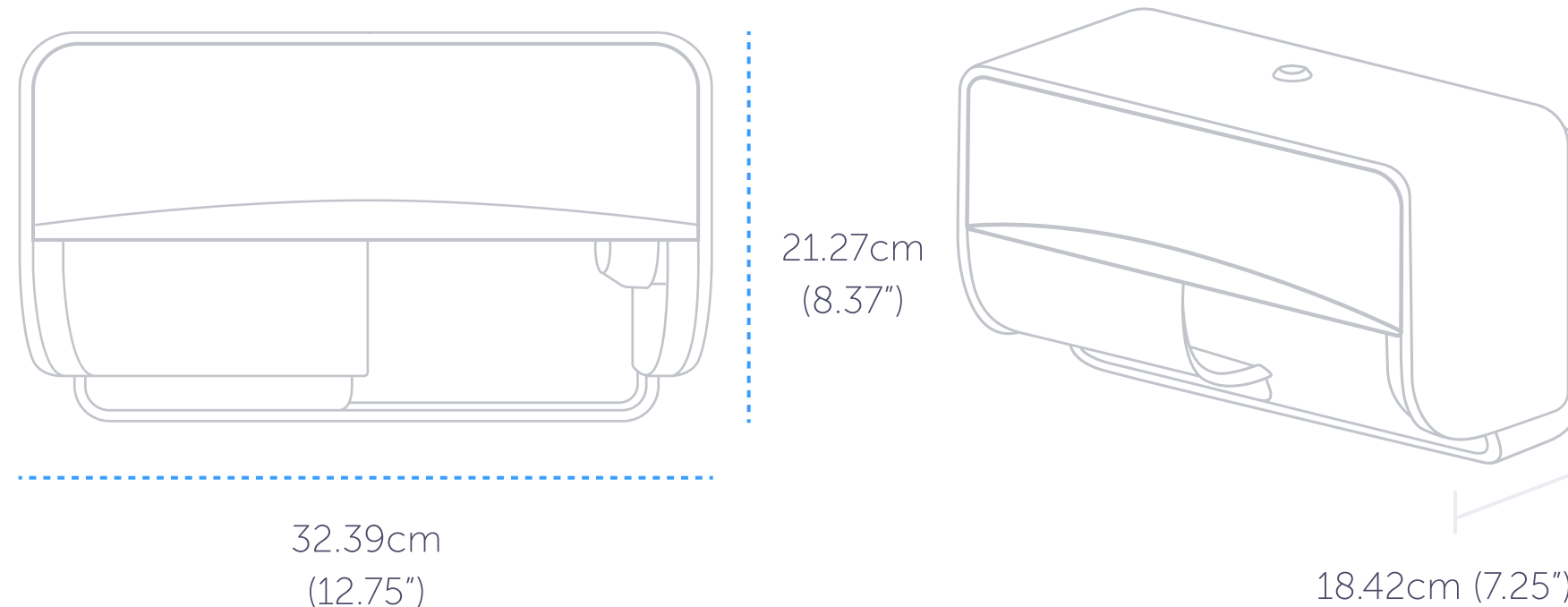

TECHNICAL SPECIFICATIONS

Suggested mounting bracket height is 81cm (31.75") from the floor.

Ensure the required clearance space is free of obstructions for proper dispenser installation.

Lifetime Warranty† ✓

DISPENSER UNITS

- Grey housing with Silver Mosaic faceplate (53655)
- White housing with White Mosaic faceplate (53945)

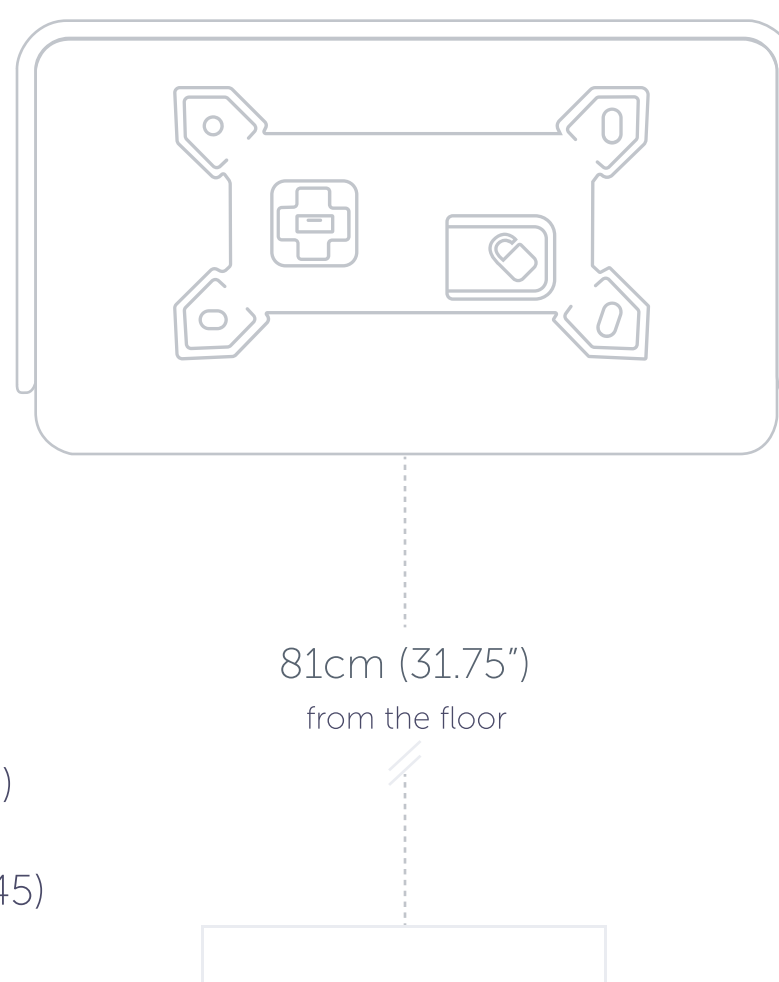

WALL MOUNTING

Mount the toilet paper dispenser 17.8cm (7") minimum and 20.3cm (9") maximum in front of the water closet measured to the centre line of the dispenser.

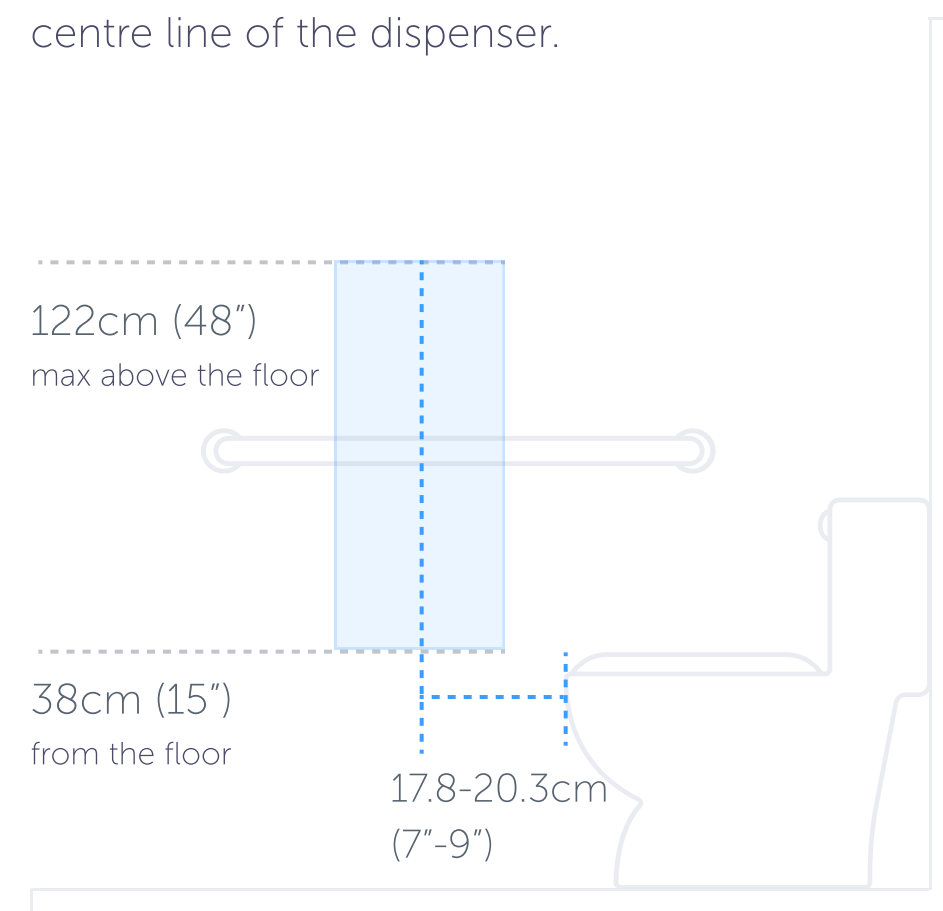

PRODUCT FEATURES

- Sleek and stylish yet suited for high-traffic washrooms, with different toilet paper options to meet your needs
- Engineered with increased accessibility for easy refilling
- Simplified installation process with custom engineered mounting brackets, a built-in level and clip-on mounting

FACEPLATES

- Black Mosaic (58782)
- White Mosaic (58772)
- Cherry Blossom (58822)
- Silver Mosaic (58762)
- Ebony Woodgrain (58832)
- Warm Marble (58792)

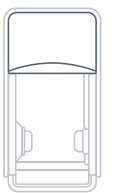

OVERVIEW

ICON™ Folded Toilet Paper Dispenser

The ICON™ folded toilet paper dispenser is designed for efficiency with less frequent and faster servicing. The design takes the washroom to the next level of hygiene with uncompromising style.

Dimensions (W x H x D)	Qty/Case
32cm x 14.5cm x 13.8cm 12.6" x 5.7" x 5.4"	1x

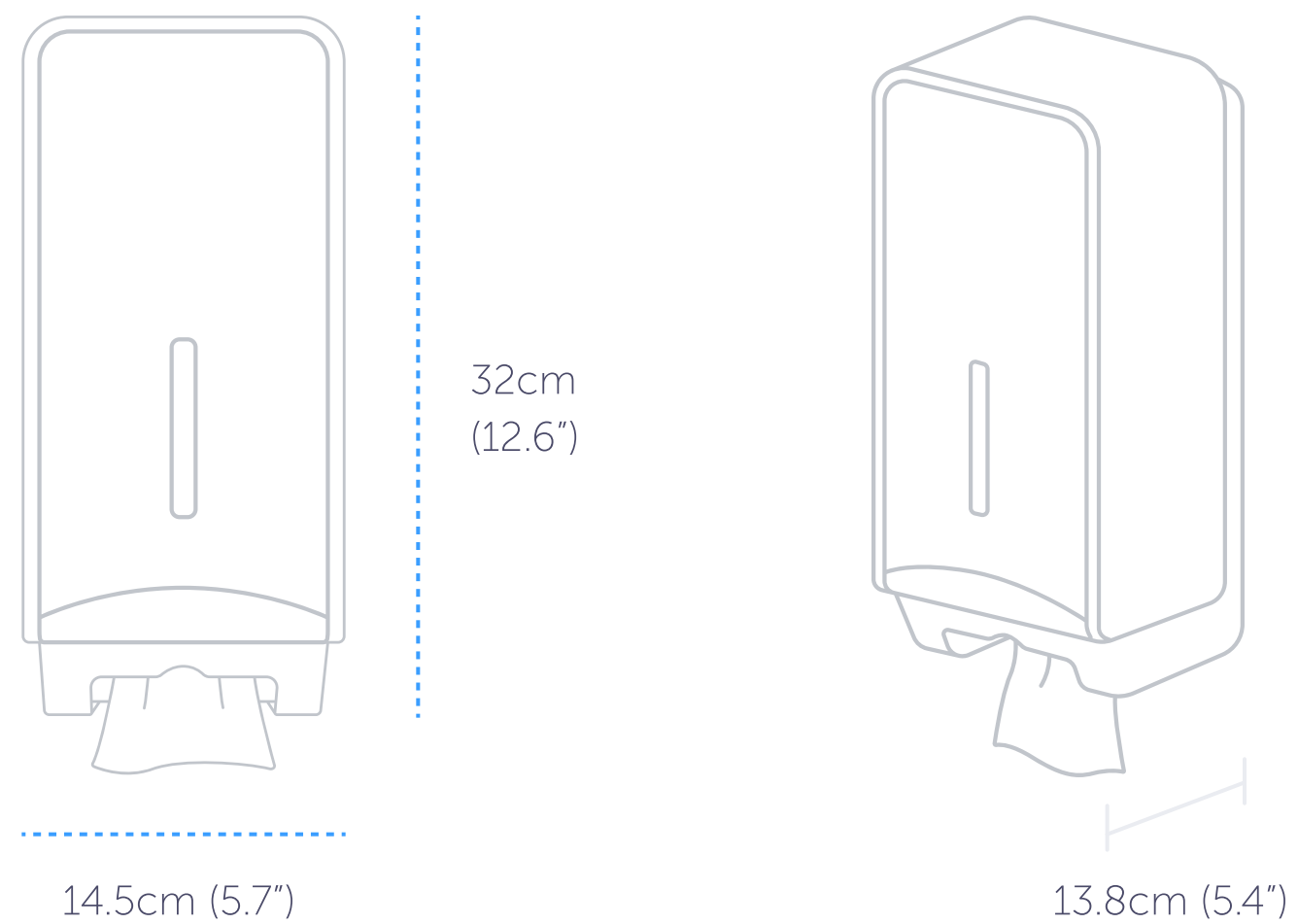

TECHNICAL SPECIFICATIONS

Suggested mounting bracket height is 81cm (31.75") from the floor.

Ensure the required clearance space is free of obstructions for proper dispenser installation.

Lifetime Warranty† ✓

DISPENSER UNITS

- Grey housing with Silver Mosaic faceplate (53659)
- White housing with White Mosaic faceplate (53949)

PRODUCT FEATURES

- Sleek and stylish yet suited for high-traffic washrooms, with different toilet paper options to meet your needs
- Engineered with increased accessibility for easy refilling

FACEPLATES

- Black Mosaic (58789)
- White Mosaic (58779)
- Cherry Blossom (58829)
- Silver Mosaic (58769)
- Ebony Woodgrain (58839)
- Warm Marble (58799)

MOUNTING REQUIREMENTS

Mount the toilet paper dispensers to be 17.8cm (7") minimum and 20.3cm (9") maximum in front of the water closet measured to the centre line of the dispenser.

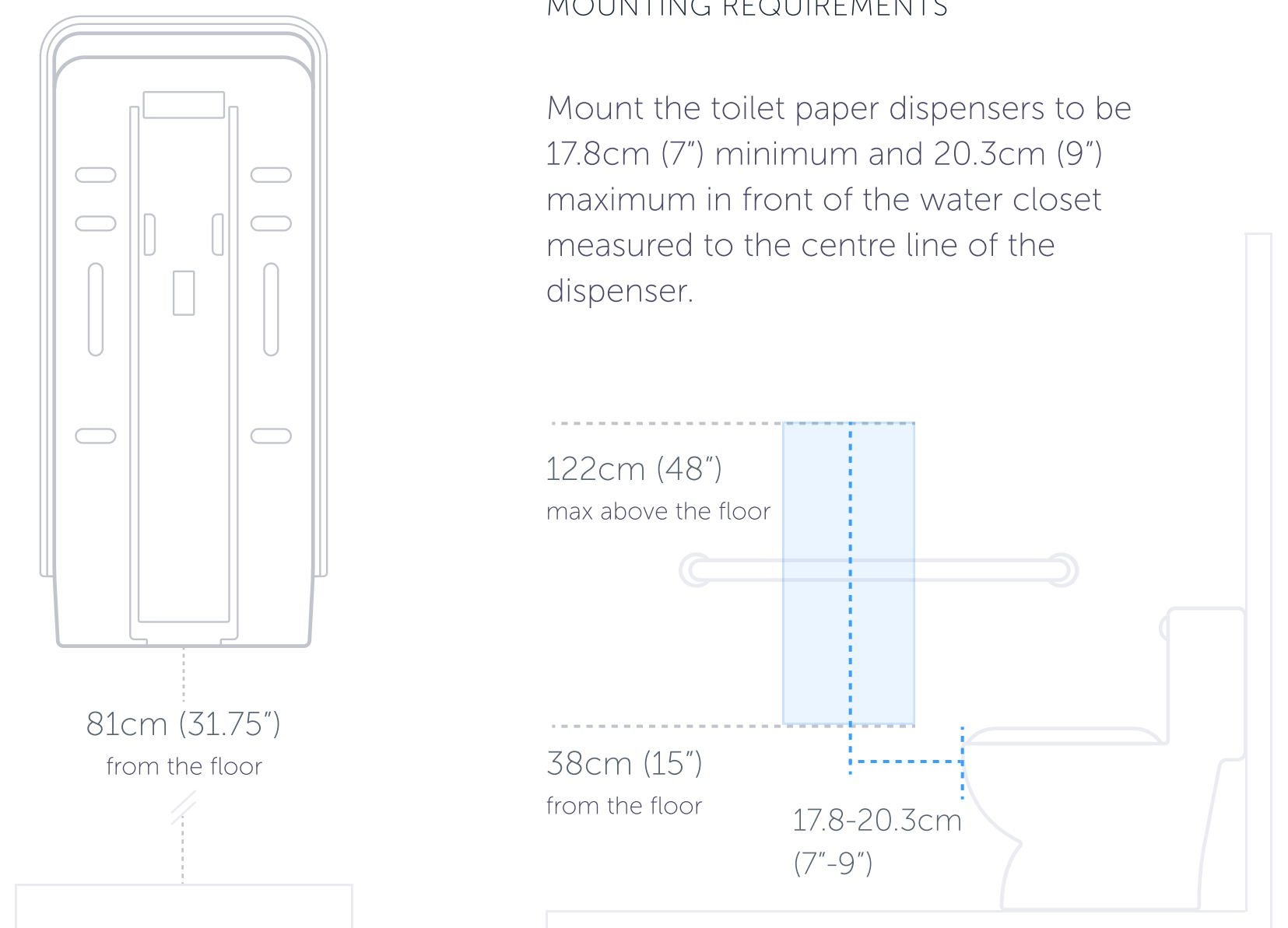

122cm (48")
max above the floor

38cm (15")
from the floor

17.8-20.3cm
(7"-9")

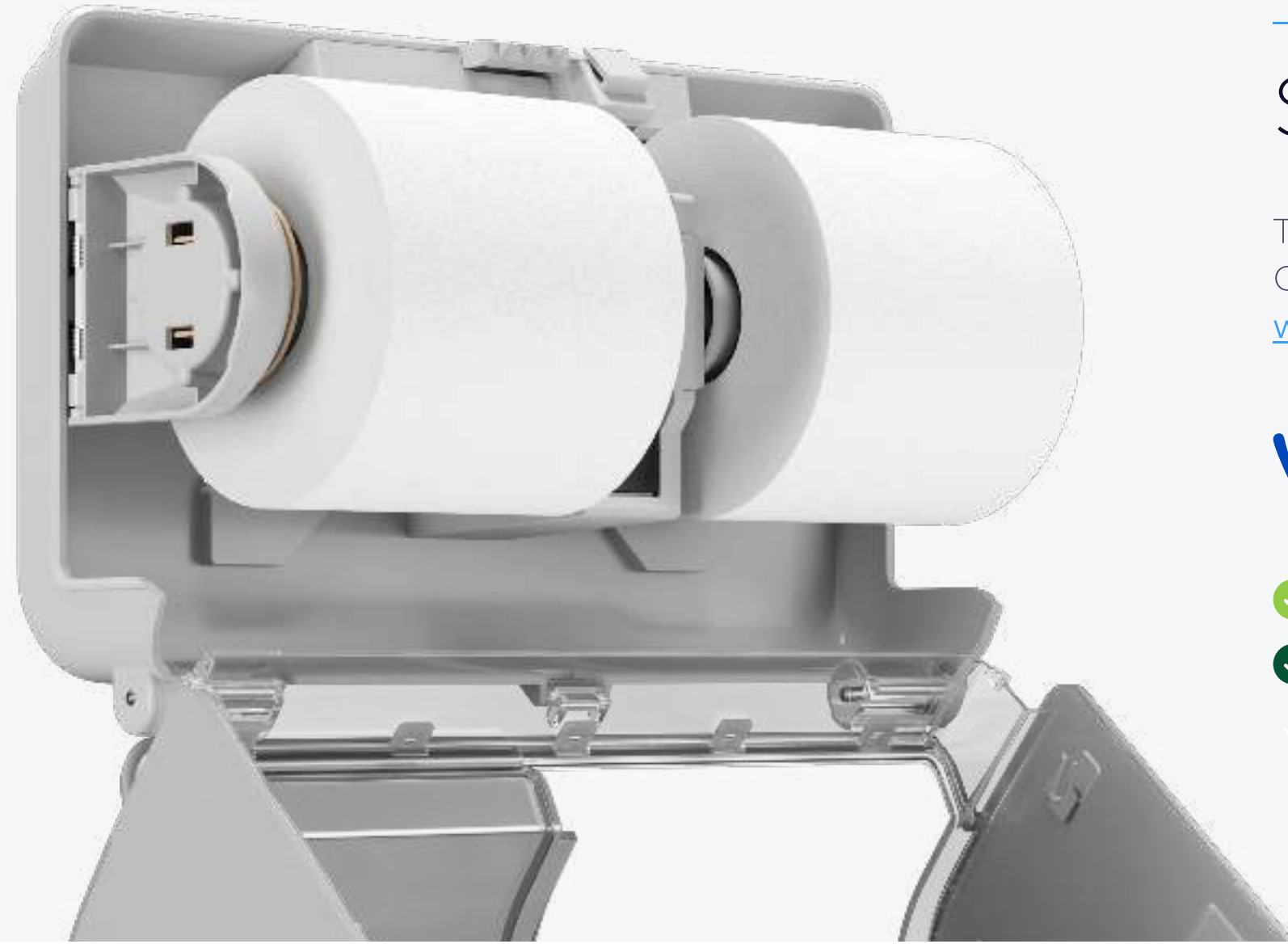



ICON™ COLLECTION

Standard Roll Toilet Paper

To learn more about product bundles please contact your Kimberly-Clark Professional Sales Representative or visit www.kcprofessional.co.uk.



- ✓ Ecolabel certified for reduced environmental impact
- ✓ FSC® certified

PLUS ✓ ✓ ✓	PREMIUM ✓ ✓ ✓
<div style="text-align: right; margin-bottom: 10px;"><i>Kleenex</i></div>  <p>Kleenex® Standard Roll Toilet Paper 8477</p> <div style="border: 1px solid #ccc; padding: 5px; width: fit-content; margin: 10px auto;">210 sheets/roll</div> <div style="margin-top: 10px;">✓</div>	<div style="text-align: right; margin-bottom: 10px;"><i>Kleenex</i></div>  <p>Kleenex® Standard Roll Toilet Paper 8459</p> <div style="border: 1px solid #ccc; padding: 5px; width: fit-content; margin: 10px auto;">195 sheets/roll</div> <div style="margin-top: 10px;">✓ ✓</div>





ICON™ COLLECTION

Folded Toilet Paper

To learn more about product bundles please contact your Kimberly-Clark Professional Sales Representative or visit www.kcprofessional.co.uk.



- ✓ Ecolabel certified for reduced environmental impact
- ✓ FSC® certified

STANDARD ✓ ✓ ✓	PREMIUM ✓ ✓ ✓
<div style="text-align: right; margin-bottom: 10px;"><i>Scott</i></div>  <p>Scott® Control™ Folded Toilet Paper 8042</p> <div style="border: 1px solid #ccc; padding: 5px; width: fit-content; margin: 10px auto;">250 sheets/clip</div> <div style="margin-top: 10px;">✓ ✓</div>	<div style="text-align: right; margin-bottom: 10px;"><i>Kleenex</i></div>  <p>Kleenex® Folded Toilet Paper 8408</p> <div style="border: 1px solid #ccc; padding: 5px; width: fit-content; margin: 10px auto;">200 sheets/clip</div> <div style="margin-top: 10px;">✓ ✓</div>



ICON™

Kimberly-Clark
PROFESSIONAL™

†Lifetime Warranty covers defects in workmanship and materials under normal use while they are installed and the end-user customer is exclusively using Kimberly-Clark Professional™ products in the dispenser. However, the warranty does not cover misuse, vandalism and/or other user-caused damage.